

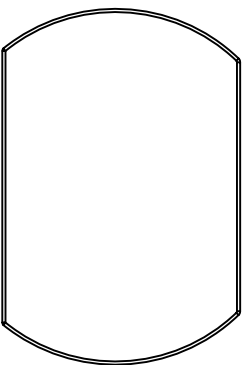

REV.	REVISIONS REC.	DATE

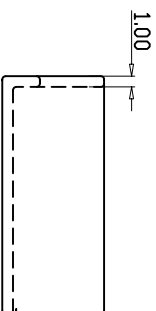
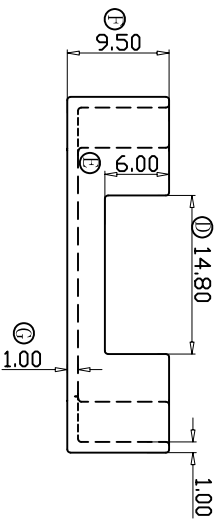
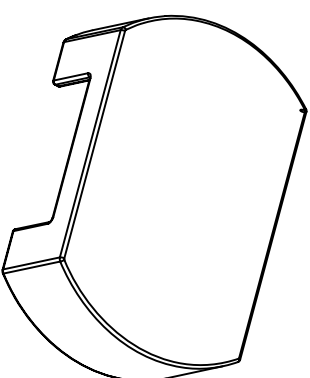
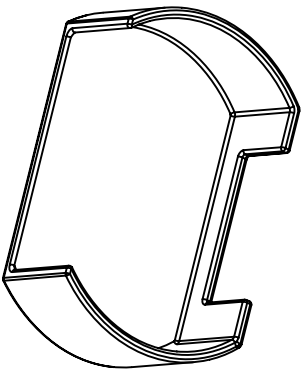
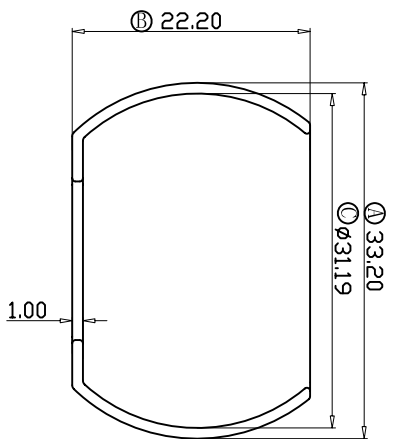

NOTE:

1. 材质: FR530 (UL94V-0, UL No. E41938)
2. 颜色: 黑色
3. 铁芯型号: PJ30
4. 需符合超越《环境关联物质管理规范》CY-QS-09008
5. 毛边最大为0.05mm
6. ****** 为主要尺寸, ****** 为次要尺寸, 其他未标示尺寸为参考尺寸, ****** 主要尺寸, IQC入料时需有检测记录

 深圳市博思康电子有限公司 SHENZHEN BOSCOM ELECTRONICS CO.,LTD		型 号		产 品 编 号	
		MODEL NAME		DRAWING NO	
ADDRESS		PJ-30(外壳)		B-3034-1	
深圳市观澜街道石马径社区君新路 石三工业区146号		MATERIAL		PIN MATERIAL: 符合ROHS/IEC要求	
TELEPHONE		SCALE		CP WIRE	
0755-28032969 28032970 28032971		FIT		符合UL94V-0标准	
FAX		DRWN BY		TOLERANCE	
0755-28032965		Z10 2015.01.09		±0.06 超越专用公差	
		DESIGNED		±0.10	
		APPROVED		±0.15 默认 ±0.06	
				10<L<=63.0 L: ±0.2 默认 ±0.06	
				63<L<=200.0 L: ±0.3 PINs: ±0.02	