

版本	A/2	REV.	REVISIONS REC.	DATE
	A/1	全面改版		2020.12.02
	A/2	①处斜面减胶修改		2021.05.04

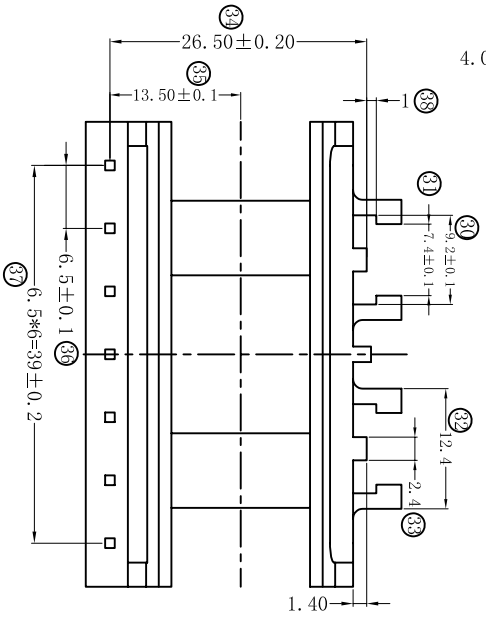
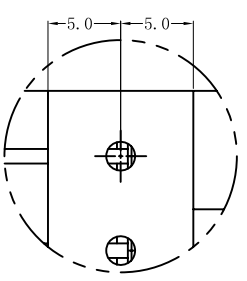
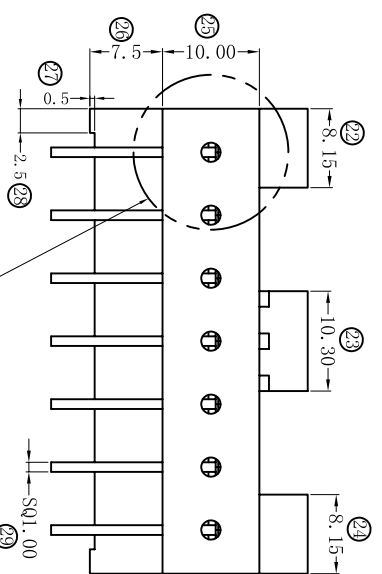
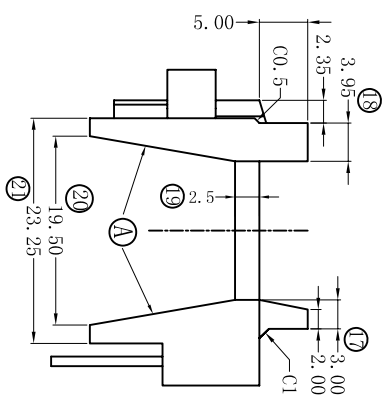
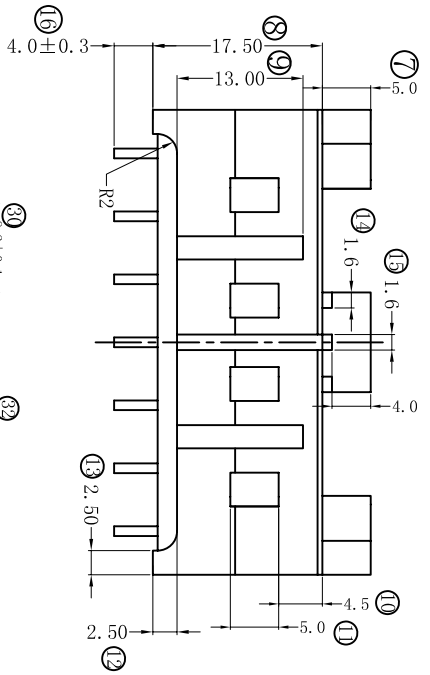
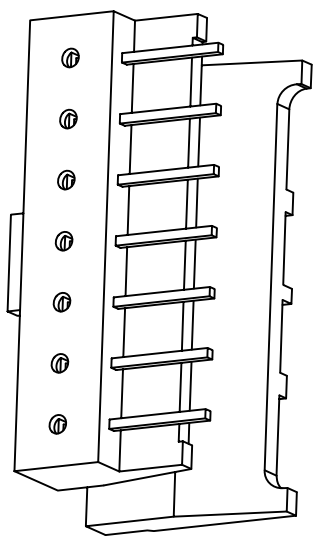
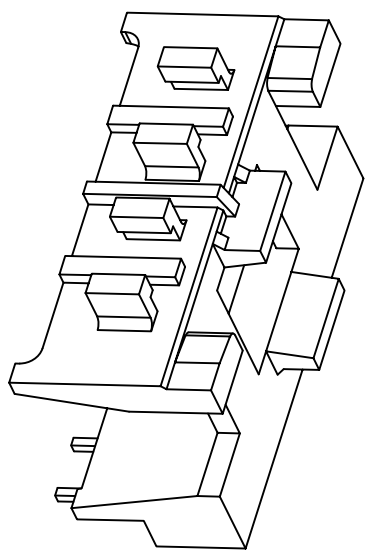
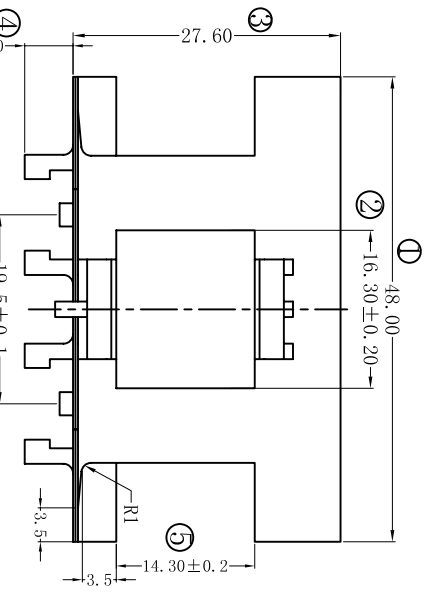

		深圳市搏思康电子有限公司 SHENZHEN BOSCOM ELECTRONICS CO.,LTD		型号	产品编号	
		深圳市观澜街道石马径社区君新路 石三工业区146号		MODEL NAME	DRAWING NO	
ADDRESS	深圳市观澜街道石马径社区君新路 石三工业区146号		BASE	B-163	客户料号:	C-B6-30068
TELEPHONE	0755-28032969 28032970 28032971		MATERIAL	FR-530 (BK)	PIN MATERIAL:	符合ROHS/IE要求
FAX	0755-28032965		SCALE	FIT	CP WIRE	符合UL94-0标准
			DRUN BY	04/05/2021	TOLERANCE	0<L≤4 ±0.10 4<L≤20 ±0.30 20<L≤200 ±0.30
			DESIGNED	庄永委		
			APPROVED			