

版本

A/0

REV

REVISIONS REC

DATE

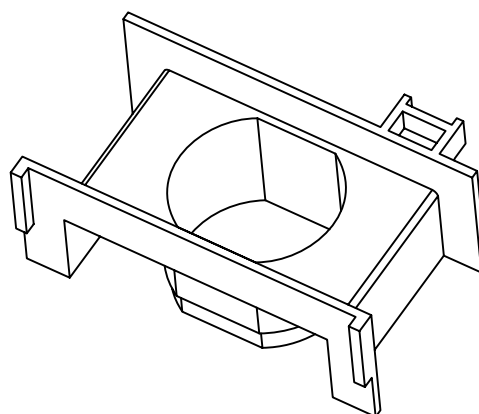
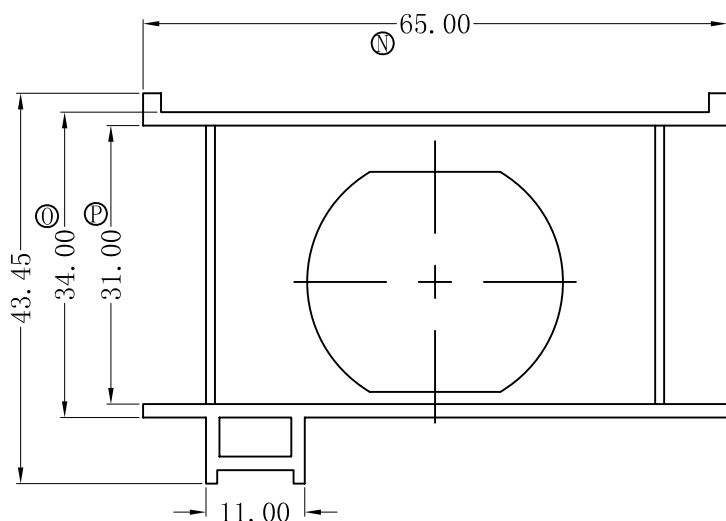
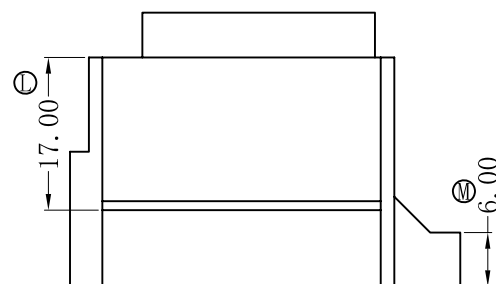
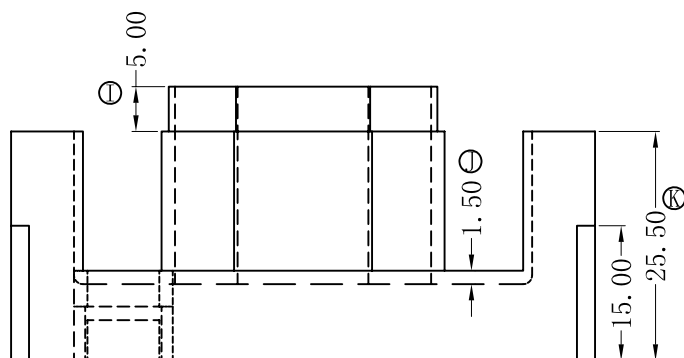
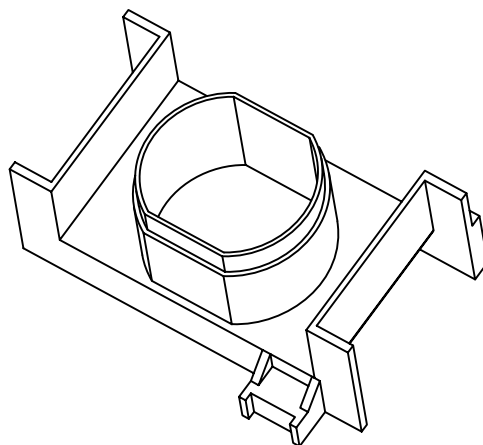
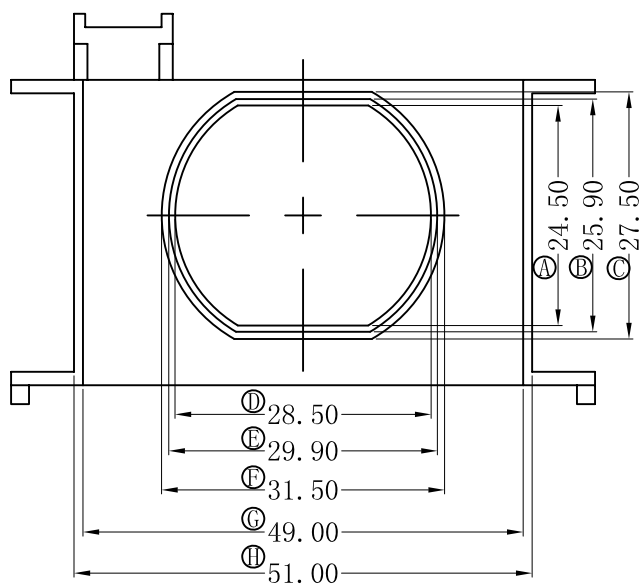

客户料号：C-Z9-05707A-02

深圳市搏思康电子有限公司

SHENZHEN BOSCOM ELECTRONICS CO., LTD

ADDRESS: 深圳市龙华区观澜街道牛湖社区君新路164号

TELEPHONE: 0755-29673660 29673519

广东搏思远科技有限公司

Guangdong Bosyuan Technology Co., Ltd

ADDRESS: 河源市高新区富民工业园A区联体厂房A栋南栋

TELEPHONE: 0762-2820657 2820658 2820659 2820660

型号

MODEL NAME

产品编号

DRAWING NO

Cover

B-B196-2

MATERIAL FR-530 BK

PIN MATERIAL CP WIRE

SCALE FIT

TOLERANCE

DRWING 24/08/2021

0 < L ≤ 4 ± 0.10

DESIGNED 庄永委

4 < L ≤ 16 ± 0.20

APPROVED

16 < L ≤ 63 ± 0.30

Pin径 ± 0.05