

版本

A/0

REV

REVISIONS REC

DATE

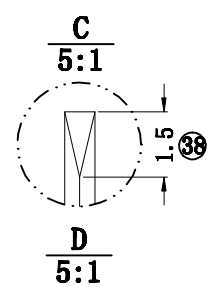
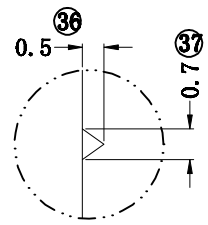
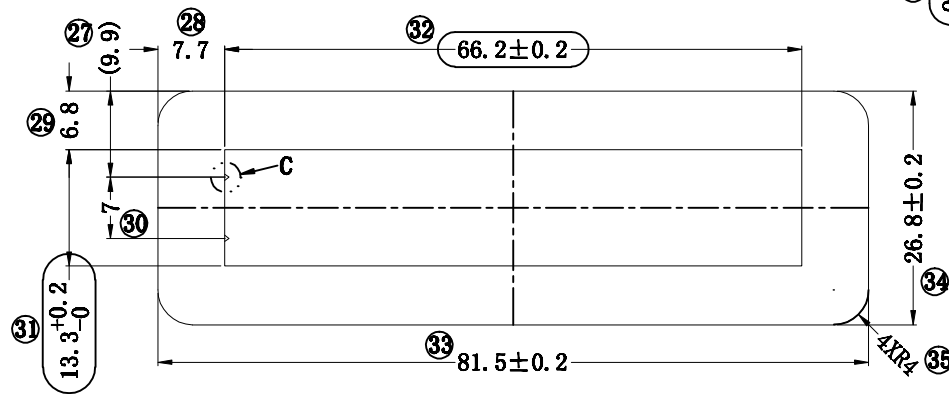
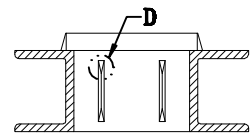
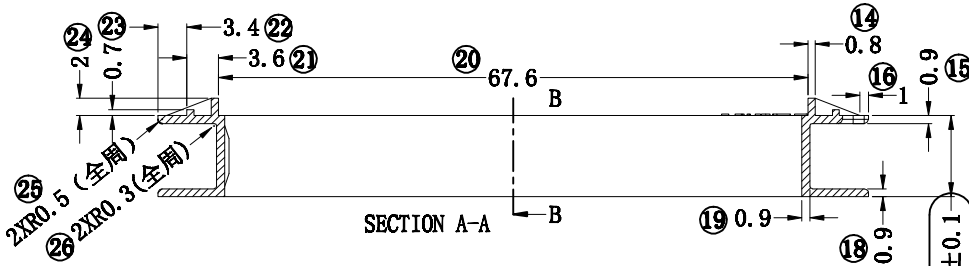
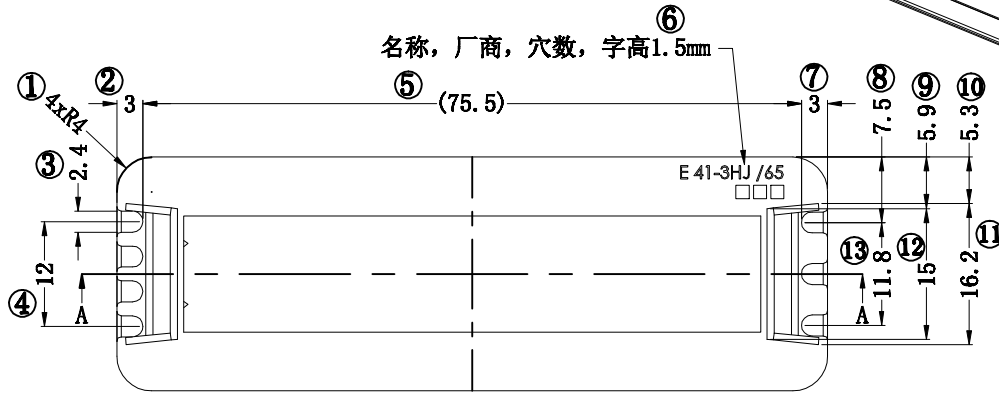
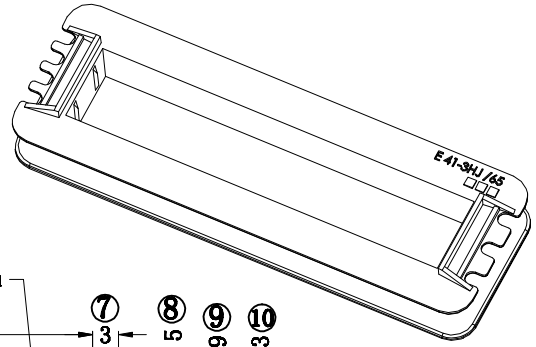

客户料号: E-B1-12192



深圳市搏思康电子有限公司
SHENZHEN BOSCOM ELECTRONICS CO., LTD

ADDRESS: 深圳市龙华区观澜街道牛湖社区君新路164号
TELEPHONE: 0755-29673660 29673519

广东搏思远科技有限公司
Guangdong Bosyuan Technology Co., Ltd

ADDRESS: 河源市高新区富民工业园A区联体厂房A栋南栋
TELEPHONE: 0762-2820657 2820658 2820659 2820660

型号
MODEL NAME

EE-41 BOBBIN

MATERIAL FR-370

SCALE FIT

DRWING 24/03/2023

DESIGNED 庄永委

APPROVED

产品编号
DRAWING NO

B-4116

PIN MATERIAL CP WIRE

TOLERANCE

0<L≤4 ±0.10
4<L≤20 ±0.20
20<L≤50 ±0.30
50<L≤200 ±0.40